



# Product Guide

Touch RFID  
Key Managed

# SOLA<sup>3</sup>

Assigned Use Functionality

Sola locks with a touch RFID interface are operated by an RFID credential or by an ADA compliant User Key. Manager Keys provide management access and external power. Programming is accomplished via a Programming Key unique to the lock system.

## Lock Orientation - Views

SOLA can be installed vertically or horizontally for left or right handed configuration.

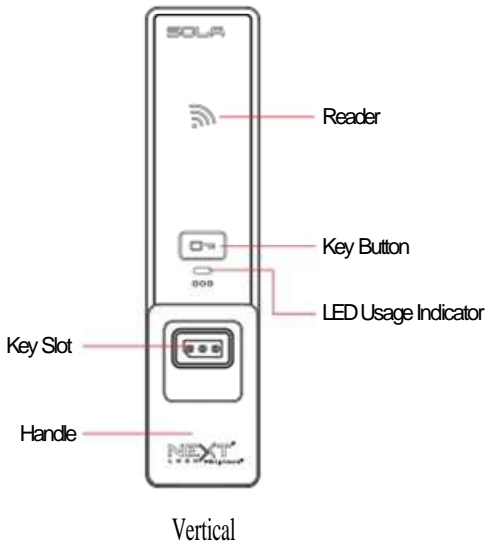

Horizontal with Handle on the Left



Horizontal with Handle on the Right

## User Credentials

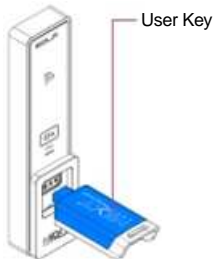

## Keys



User Key



Manager Key<sub>1</sub>



Programming Key<sub>2</sub>

|   | User Key | Manager Key <sub>1</sub> | Programming Key <sub>2</sub> |
|---|----------|--------------------------|------------------------------|
| Operates the lock                       | •        | •                        | •                            |
| Overrides user access                   |          | •                        | •                            |
| Allows access for management inspection |          | •                        | •                            |
| Provides external power                 |          | •                        | •                            |
| Assigns user credential                 |          | •                        |                              |
| Programs Manager Keys to the lock       |          |                          | •                            |

• Up to 25 Manager Keys may be programmed to a lock.    • 1 Programming Key allowed per lock group.

## Key Insertion



Horizontal - Handle on Left

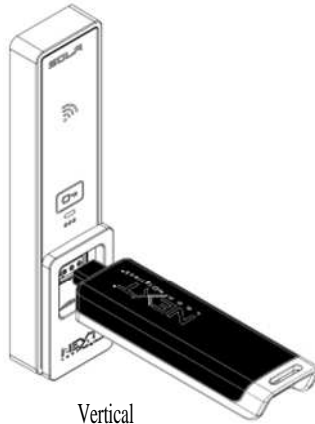

Vertical

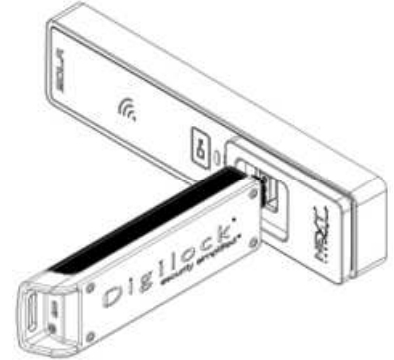

Horizontal - Handle on Right

## Handle Positions

90°

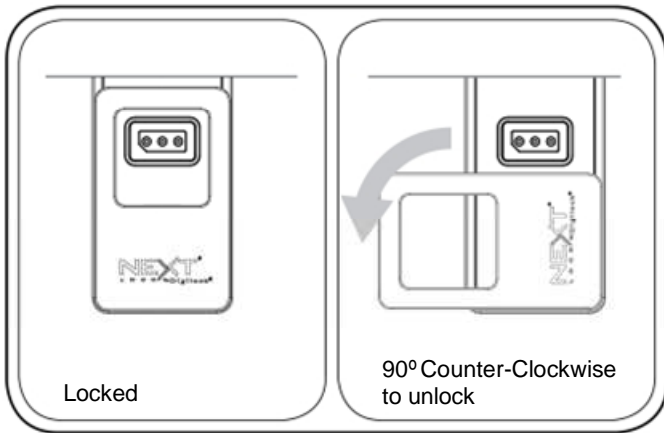

OR

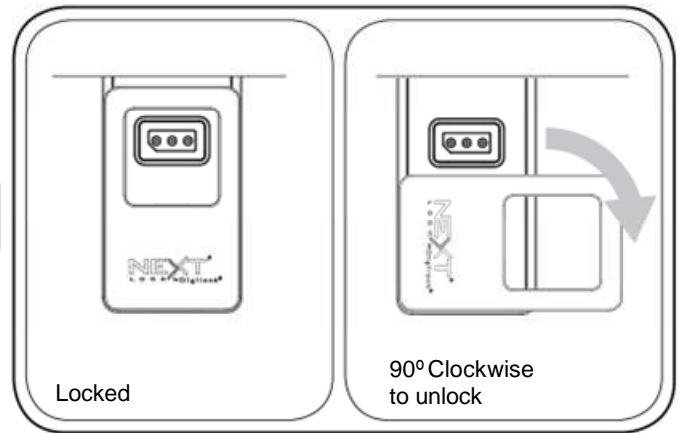

180°

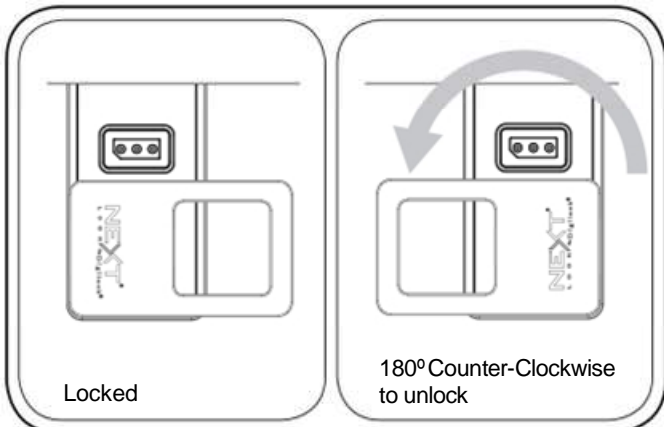

OR

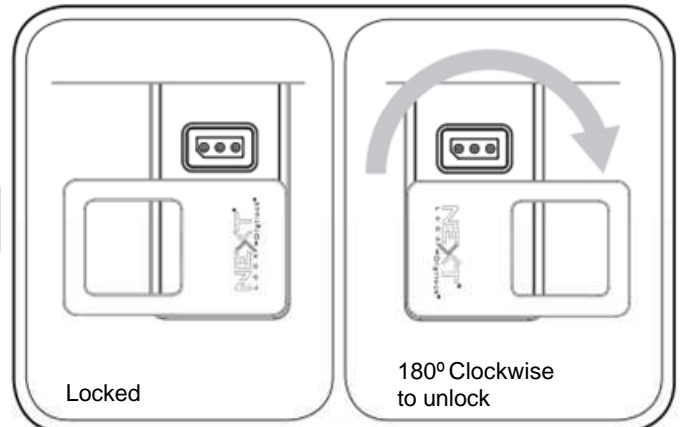

## Setup

Locks are shipped with factory default settings (only operates by pressing ). Each lock must be set up to operate with a Programming Key and Manager Keys.

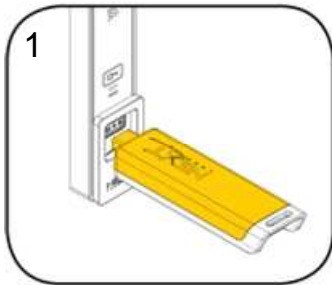

1 Insert the Programming Key. A two-tone beep will be heard and the LED will flash.

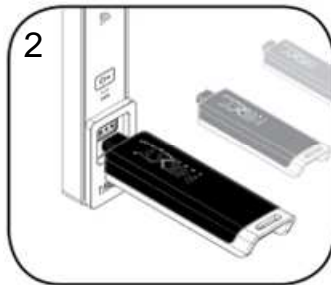

2 While the LED is flashing, insert one Manager Key at a time. A two-tone beep will be heard for each Manager Key programmed.

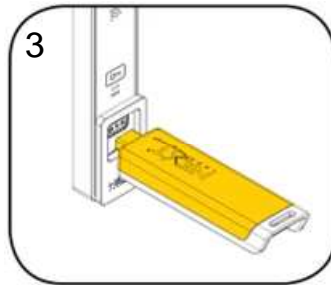

3 While the LED is flashing, insert the Programming Key. A two-tone beep will be heard and the LED will turn off.

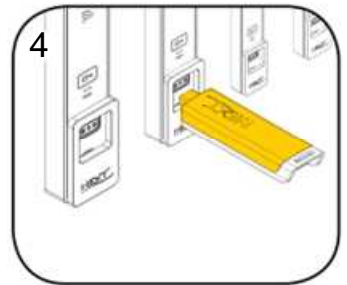



4 Repeat above steps for each lock or follow instructions to Express Register Manager Keys to setup all locks.

## Programming Instructions

### Express Register Manager Keys

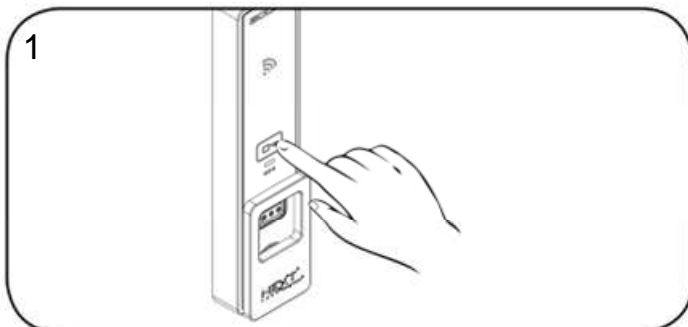
The Programming Key can quickly program multiple locks to operate with the same Manager Keys.



1 Go to the lock already programmed to operate with the Manager Keys. Touch and hold  for 10 seconds (a two-tone beep will be heard after 5 seconds followed by 2 sets of two-tone beeps after 10 seconds) then release. The LED will flash.

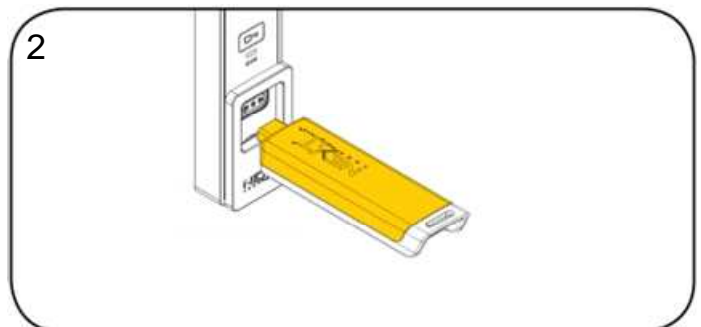

2 While the LED is flashing, insert the Programming Key. A two-tone beep will be heard and the LED will turn off.

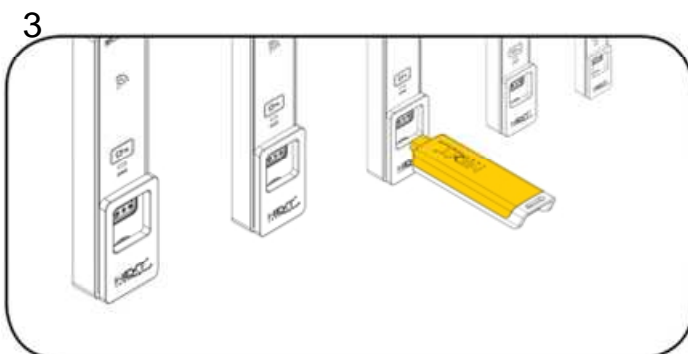

3 At each lock to be programmed, insert the Programming Key. A two-tone beep will be heard and the LED will flash once to indicate successful registration.

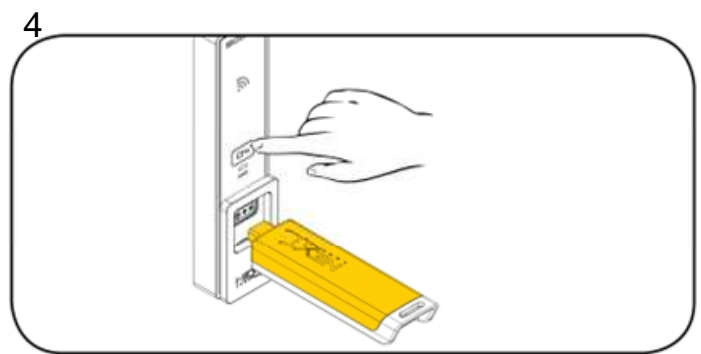

4 To end Express Registration mode:\* Go to any programmed lock. Press  then insert the Programming Key.

\*The Programming Key will continue to function in Express Registration mode until it is used to operate a lock.

## Programming Instructions

### Add Manager Keys

Manager Keys can be programmed to the locks at any time.

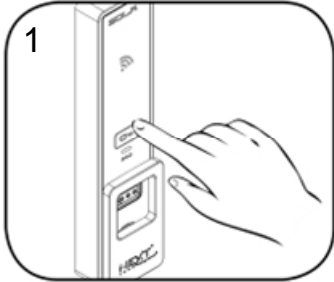

1  
Go to a lock requiring additional Manager Keys.  
Touch and hold  for 5 seconds (a two-tone beep will be heard after 5 seconds) then release.  
The LED will flash.

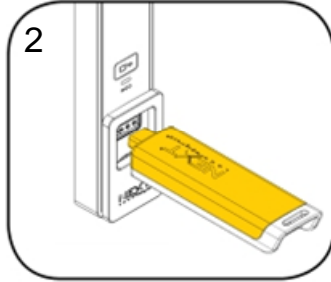

2  
While the LED is flashing, insert the Programming Key.  
A two-tone beep will be heard.

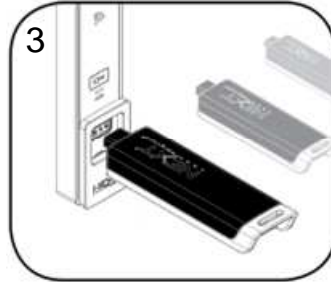

3  
While the LED is flashing, insert each additional Manager Key one at a time.  
A two-tone beep will be heard for each Manager Key programmed.

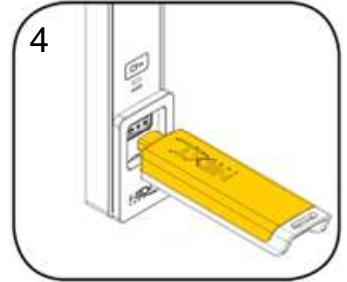

4  
Insert the Programming Key.  
A two-tone beep will be heard and the LED will turn off.  
Repeat above steps for each lock or follow instructions to Express Register Manager Keys to quickly program multiple locks to operate with the same Manager Keys.

### Replace Keys

The locks must be reprogrammed to prevent the lost/stolen keys from operating a lock.

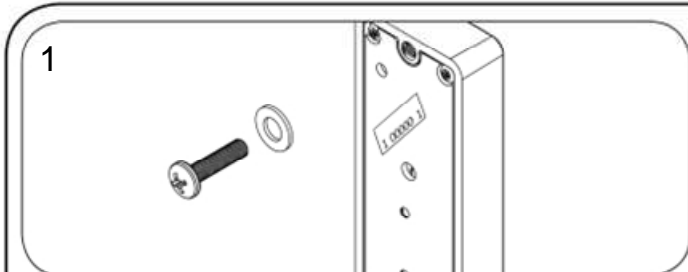

1  
**To replace the Programming Key:**  
Note the order or serial number (found on the lock's rear).



2  
Contact supplier to purchase a replacement Programming Key.

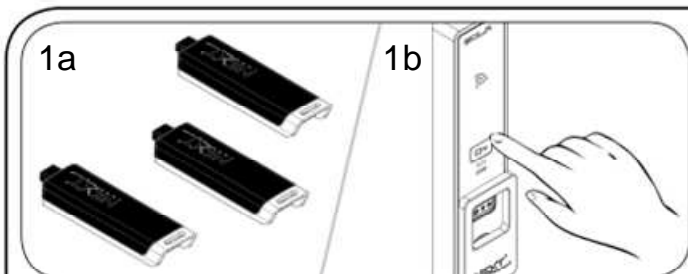

1a  
**To replace the Manager Keys:**  
Collect all remaining and replacement Manager Keys.  
Go to any lock operated by the lost/stolen Manager Keys. Touch and hold  for 5 seconds (a two-tone beep will be heard after 5 seconds) then release.  
The LED will flash.

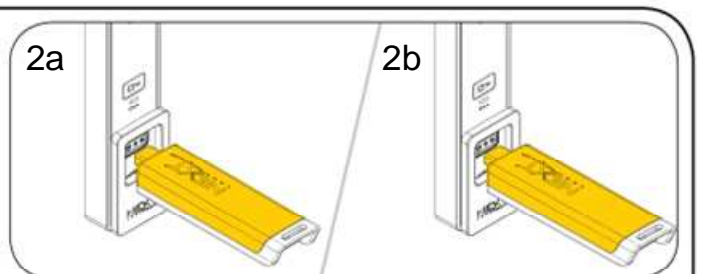

2a  
While the LED is flashing, insert the Programming Key.  
A two-tone beep will be heard.  
Insert the Programming Key again.  
Three sets of two-tone beeps will be heard and the LED will turn off. All previously programmed Manager Keys will be erased.  
Follow instructions to Add Manager Keys to program the remaining and replacement Manager Keys to the locks.

## Programming Instructions

### Assign the User Credential

Once a user credential is assigned, the previously assigned user credential will no longer operate the lock.

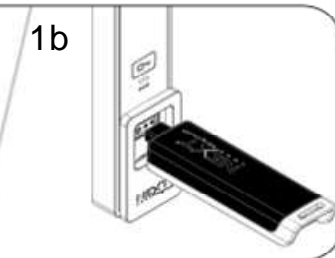



**1a**

**1b**



**2**

**Assign a User RFID Credential:**  
 Touch and hold  for 5 seconds (a two-tone beep will be heard after 5 seconds) then release.  
 The LED will flash and the RFID reader will turn on.  
 Insert a valid Manager Key.  
 A two-tone beep will be heard.

Present the RFID credential to the RFID reader.  
 Two sets of two-tone beeps will be heard and the LED and RFID reader will turn off.

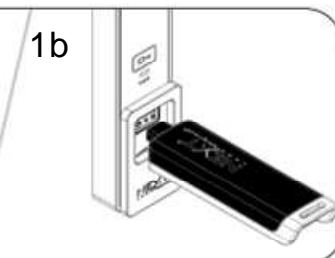

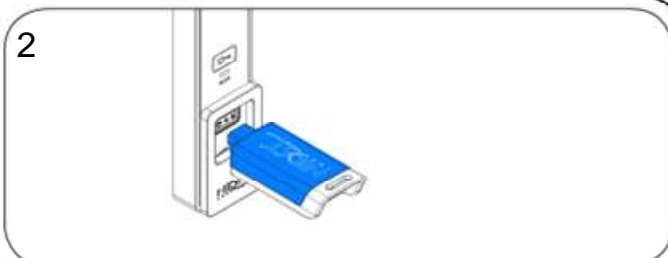

**1a**

**1b**



**2**

**Assign a User Key:**  
 Touch and hold  for 5 seconds (a two-tone beep will be heard after 5 seconds) then release.  
 The LED will flash and the RFID reader will turn on.  
 Insert a valid Manager Key.  
 A two-tone beep will be heard.

While the LED is on, insert a User Key.  
 A two-tone beep will be heard and the LED will turn off.

## Operating Instructions - In Assigned Use Functionality

In assigned use functionality, users operate the lock with their assigned user credential (either a User Code or a User Key). To reassign a lock to a different user, follow instructions to Assign the User Credential.

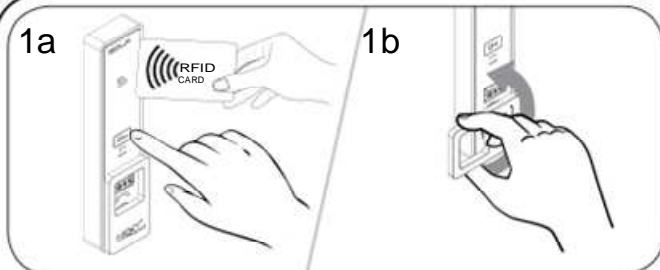

**1a** **1b**

**Operate with the RFID credential**  
To unlock: Touch  then present the assigned RFID credential then turn the handle to the unlocked position. Open the door.\*

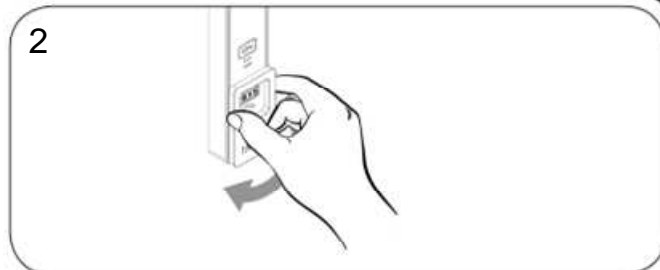

**2**

To relock: Close the door then turn the handle to the locked position.

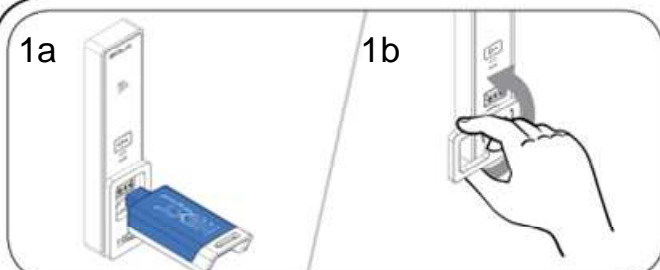

**1a** **1b**

**Operate with the User Key**  
To unlock: Insert the assigned User Key then turn the handle to the unlocked position. Open the door.\*

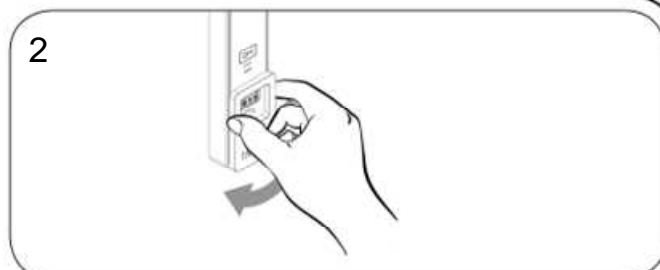

**2**

To relock: Close the door then turn the handle to the locked position.

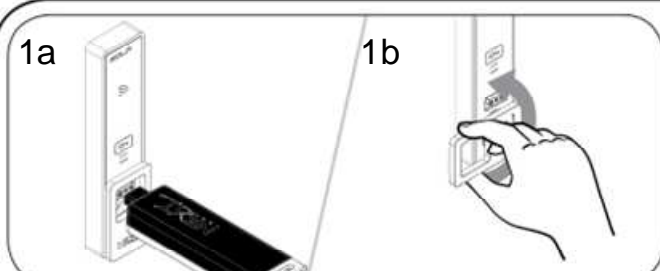

**1a** **1b**

**Operate with a Manager Key**  
To unlock: Insert a valid Manager Key then turn the handle to the unlocked position. Open the door.\*

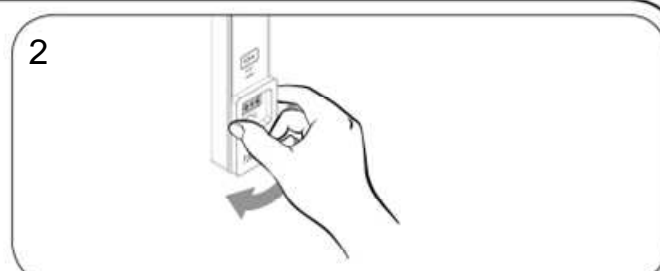

**2**

To relock: Close the door then turn the handle to the locked position.

\*The lock will remain in the locked position if the handle is not turned within approximately 6 seconds.

## Support

### Low Battery Indicator

After locking or unlocking, the lock emits two sets of three beeps indicating that the batteries are low. Replace the batteries.

### Does not Unlock with the User RFID Credential or User Key

The lock does not recognize the User Code or User Key. For immediate access, operate with a valid Manager Key then follow instructions to Assign the User Credential to assign a new User RFID Credential or User Key to the lock.

### Does not Operate with a Manager Key

The lock does not recognize the Manager Key. Follow instructions to Add Manager Keys to program the Manager Key to the lock. For immediate access, operate with another valid Manager Key.

### Does not Operate with the Programming Key

The lock does not recognize the Programming Key. If the Programming Key has been replaced, operate with the Replacement Programming Key. Contact supplier for additional assistance.

### Does No Audible Feedback when is Pressed

The batteries may need to be replaced. For immediate access, operate with a valid Manager Key.

## Battery Replacement

It is not necessary to uninstall the lock from the door.  
In case of battery failure, operate with a valid Manager Key.

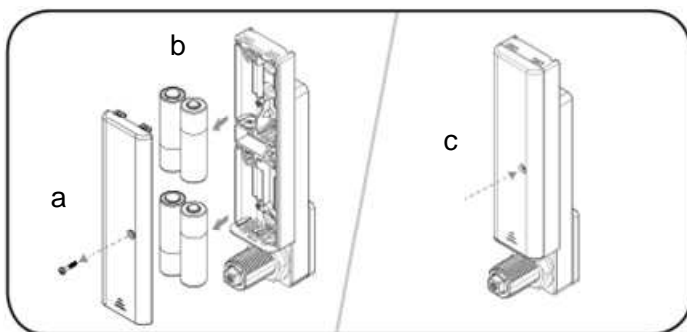

- Remove the screw and the battery cover.
- Replace the four premium AA batteries.
- Replace battery cover and screw.